

SKM 200GB176D...



SEMITRANS® 3

Trench IGBT Modules

SKM 200GB176D

SKM 200GAL176D

Preliminary Data

Features

- Homogeneous Si
- Trench = Trenchgate technology
- V_{CEsat} with positive temperature coefficient
- High short circuit capability, self limiting to $6 \times I_C$

Typical Applications

- AC inverter drives mains 575 - 750 V AC
- Public transport (auxiliary syst.)

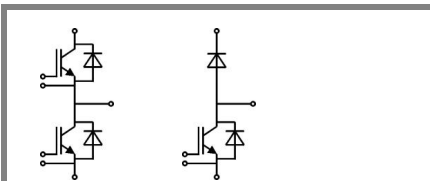

GB

GAL

Absolute Maximum Ratings		$T_c = 25^\circ\text{C}$, unless otherwise specified		
Symbol	Conditions	Values		Units
IGBT				
V_{CES}	$T_j = 25^\circ\text{C}$	1700		V
I_C	$T_j = 150^\circ\text{C}$	$T_c = 25^\circ\text{C}$	260	A
		$T_c = 80^\circ\text{C}$	180	A
I_{CRM}	$I_{CRM} = 2 \times I_{Cnom}$	300		A
V_{GES}		± 20		V
t_{psc}	$V_{CC} = 1200\text{ V}; V_{GE} \leq 20\text{ V}; T_j = 125^\circ\text{C}$ $V_{CES} < 1700\text{ V}$	10		µs
Inverse Diode				
I_F	$T_j = 150^\circ\text{C}$	$T_c = 25^\circ\text{C}$	210	A
		$T_c = 80^\circ\text{C}$	140	A
I_{FRM}	$I_{FRM} = 2 \times I_{Fnom}$	300		A
I_{FSM}	$t_p = 10\text{ ms}; \sin.$	$T_j = 150^\circ\text{C}$	1100	A
Freewheeling Diode				
I_F	$T_j = 150^\circ\text{C}$	$T_{case} = 25^\circ\text{C}$	210	A
		$T_{case} = 80^\circ\text{C}$	140	A
I_{FRM}	$I_{FRM} = 2 \times I_{Fnom}$	300		A
I_{FSM}	$t_p = 10\text{ ms}; \sin.$	$T_j = 150^\circ\text{C}$	1100	A
Module				
$I_{t(RMS)}$		500		A
T_{vj}		- 40 ... + 150		°C
T_{stg}		-40...+125		°C
V_{isol}	AC, 1 min.	4000		V

Characteristics		$T_c = 25^\circ\text{C}$, unless otherwise specified			
Symbol	Conditions	min.	typ.	max.	Units
IGBT					
$V_{GE(th)}$	$V_{GE} = V_{CE}, I_C = 6\text{ mA}$	5,2	5,8	6,4	V
I_{CES}	$V_{GE} = 0\text{ V}, V_{CE} = V_{CES}$		0,1	0,3	mA
V_{CE0}		$T_j = 25^\circ\text{C}$	1	1,2	V
		$T_j = 125^\circ\text{C}$	0,9	1,1	V
r_{CE}	$V_{GE} = 15\text{ V}$	$T_j = 25^\circ\text{C}$	6,7	8,3	mΩ
		$T_j = 125^\circ\text{C}$	10	12	mΩ
$V_{CE(sat)}$	$I_{Cnom} = 150\text{ A}, V_{GE} = 15\text{ V}$	$T_j = 25^\circ\text{C}_{chiplev.}$	2	2,45	V
		$T_j = 125^\circ\text{C}_{chiplev.}$	2,4	2,9	V
C_{ies}	$V_{CE} = 25, V_{GE} = 0\text{ V}$	$f = 1\text{ MHz}$	11,4		nF
C_{oes}			0,55		nF
C_{res}			0,44		nF
Q_G	$V_{GE} = -8\text{V}...+15\text{V}$	1200		nC	
R_{Gint}	$T_j = 25^\circ\text{C}$	4,25		Ω	
$t_{d(on)}$	$R_{Gon} = 5\ \Omega$	$V_{CC} = 1200\text{V}$ $I_{Cnom} = 150\text{A}$	360		ns
			$T_j = 125^\circ\text{C}$	45	ns
E_{on}	$R_{Goff} = 5\ \Omega$	$V_{GE} = \pm 15\text{V}$	93		mJ
$t_{d(off)}$			760		ns
t_f			140		ns
E_{off}			58		mJ
$R_{th(j-c)}$	per IGBT			0,12	K/W



SEMITRANS® 3

Trench IGBT Modules

SKM 200GB176D

SKM 200GAL176D

Preliminary Data

Features

- Homogeneous Si
- Trench = Trenchgate technology
- V_{CEsat} with positive temperature coefficient
- High short circuit capability, self limiting to $6 \times I_c$

Typical Applications

- AC inverter drives mains 575 - 750 V AC
- Public transport (auxiliary syst.)

Characteristics							
Symbol	Conditions			min.	typ.	max.	Units
Inverse Diode							
$V_F = V_{EC}$	$I_{Fnom} = 150 \text{ A}; V_{GE} = 0 \text{ V}$	$T_j = 25 \text{ }^\circ\text{C}_{chiplev.}$			1,7	1,9	V
		$T_j = 125 \text{ }^\circ\text{C}_{chiplev.}$			1,7	1,9	V
V_{F0}		$T_j = 25 \text{ }^\circ\text{C}$			1,1	1,3	V
		$T_j = 125 \text{ }^\circ\text{C}$			0,9	1,1	V
r_F		$T_j = 25 \text{ }^\circ\text{C}$			4	4	mΩ
		$T_j = 125 \text{ }^\circ\text{C}$			5,3	5,3	mΩ
I_{RRM}	$I_{Fnom} = 150 \text{ A}$ $di/dt = 3700 \text{ A}/\mu\text{s}$ $V_{GE} = -15 \text{ V}; V_{CC} = 1200 \text{ V}$	$T_j = 125 \text{ }^\circ\text{C}$			195		A
Q_{rr}					52		μC
E_{rr}					31		mJ
$R_{th(j-c)D}$	per diode					0,25	K/W
FWD							
$V_F = V_{EC}$	$I_{Fnom} = 150 \text{ A}; V_{GE} = 0 \text{ V}$	$T_j = 25 \text{ }^\circ\text{C}_{chiplev.}$			1,7	1,9	V
		$T_j = 125 \text{ }^\circ\text{C}_{chiplev.}$			1,7	1,9	V
V_{F0}		$T_j = 25 \text{ }^\circ\text{C}$			1,1	1,3	V
		$T_j = 125 \text{ }^\circ\text{C}$			0,9	1,1	V
r_F		$T_j = 25 \text{ }^\circ\text{C}$			4	4	V
		$T_j = 125 \text{ }^\circ\text{C}$			5,3	5,3	V
I_{RRM}	$I_{Fnom} = 150 \text{ A}$ $di/dt = 3700 \text{ A}/\mu\text{s}$ $V_{GE} = -15 \text{ V}; V_{CC} = 1200 \text{ V}$	$T_j = 125 \text{ }^\circ\text{C}$			195		A
Q_{rr}					52		μC
E_{rr}					31		mJ
$R_{th(j-c)FD}$	per diode					0,25	K/W
Module							
L_{CE}					15	20	nH
$R_{CC'+EE'}$	res., terminal-chip	$T_{case} = 25 \text{ }^\circ\text{C}$			0,35		mΩ
		$T_{case} = 125 \text{ }^\circ\text{C}$			0,5		mΩ
$R_{th(c-s)}$	per module					0,038	K/W
M_s	to heat sink M6				3	5	Nm
M_t	to terminals M6				2,5	5	Nm
w						325	g

This is an electrostatic discharge sensitive device (ESDS), international standard IEC 60747-1, Chapter IX.

This technical information specifies semiconductor devices but promises no characteristics. No warranty or guarantee expressed or implied is made regarding delivery, performance or suitability.

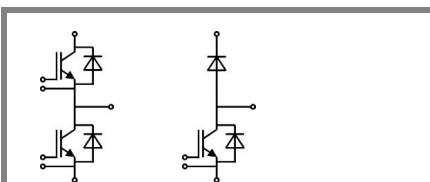

GB

GAL



SEMITRANS® 3

Trench IGBT Modules

SKM 200GB176D

SKM 200GAL176D

Preliminary Data

Features

- Homogeneous Si
- Trench = Trenchgate technology
- V_{CEsat} with positive temperature coefficient
- High short circuit capability, self limiting to $6 \times I_c$

Typical Applications

- AC inverter drives mains 575 - 750 V AC
- Public transport (auxiliary syst.)

Z_{th}		Conditions	Values	Units
Symbol				
$Z_{th(j-c)I}$				
$R_{\theta j-c}$	$i = 1$		80	mk/W
$R_{\theta j-c}$	$i = 2$		30	mk/W
$R_{\theta j-c}$	$i = 3$		8,2	mk/W
$R_{\theta j-c}$	$i = 4$		1,8	mk/W
$\tau_{th(j-c)I}$	$i = 1$		0,0753	s
$\tau_{th(j-c)I}$	$i = 2$		0,01	s
$\tau_{th(j-c)I}$	$i = 3$		0,0008	s
$\tau_{th(j-c)I}$	$i = 4$		0,0003	s
Symbol				
$Z_{th(j-c)D}$				
$R_{\theta j-c}$	$i = 1$		160	mk/W
$R_{\theta j-c}$	$i = 2$		67	mk/W
$R_{\theta j-c}$	$i = 3$		20	mk/W
$R_{\theta j-c}$	$i = 4$		3	mk/W
$\tau_{th(j-c)D}$	$i = 1$		0,0382	s
$\tau_{th(j-c)D}$	$i = 2$		0,009	s
$\tau_{th(j-c)D}$	$i = 3$		0,0009	s
$\tau_{th(j-c)D}$	$i = 4$		0,005	s

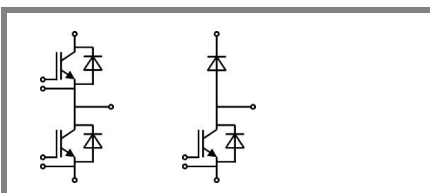

GB

GAL

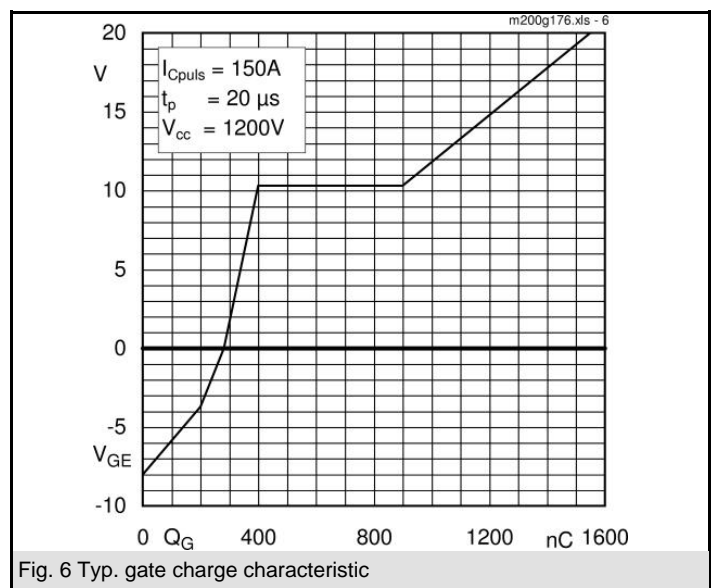
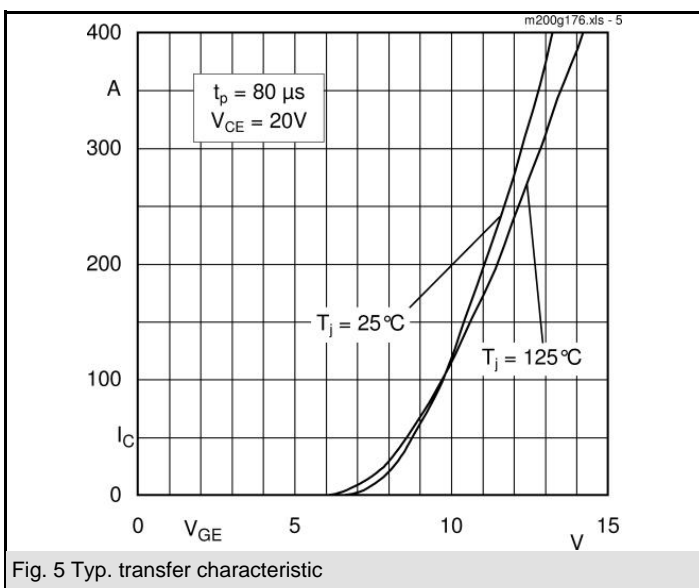
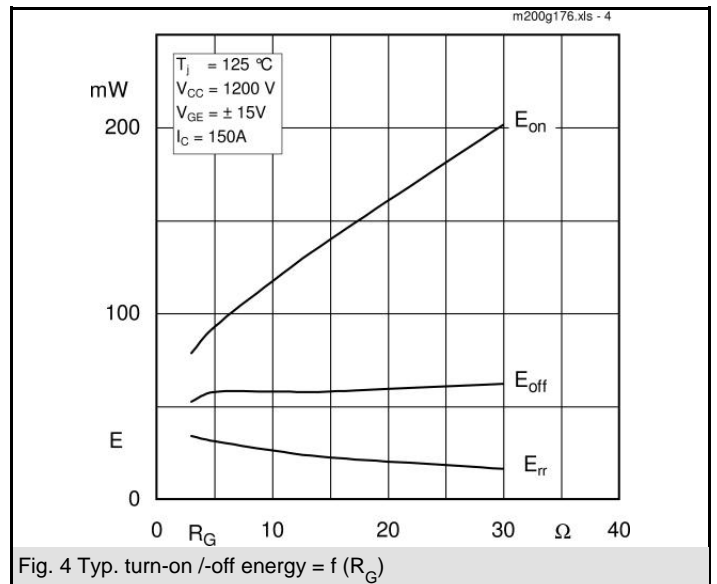
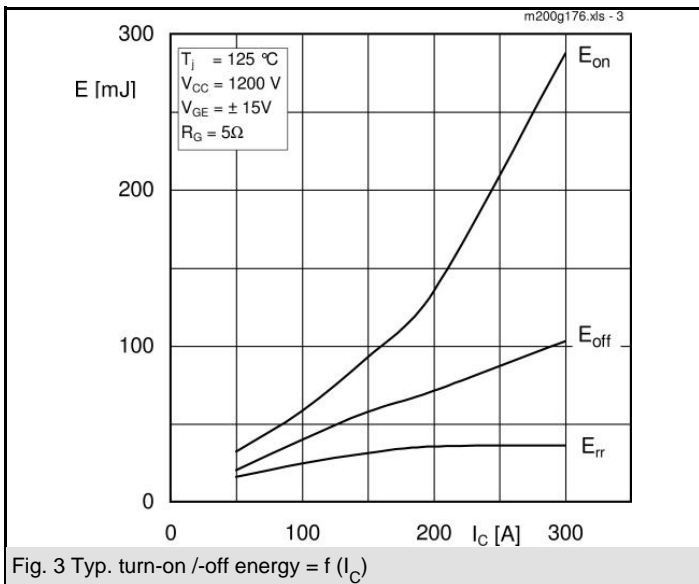
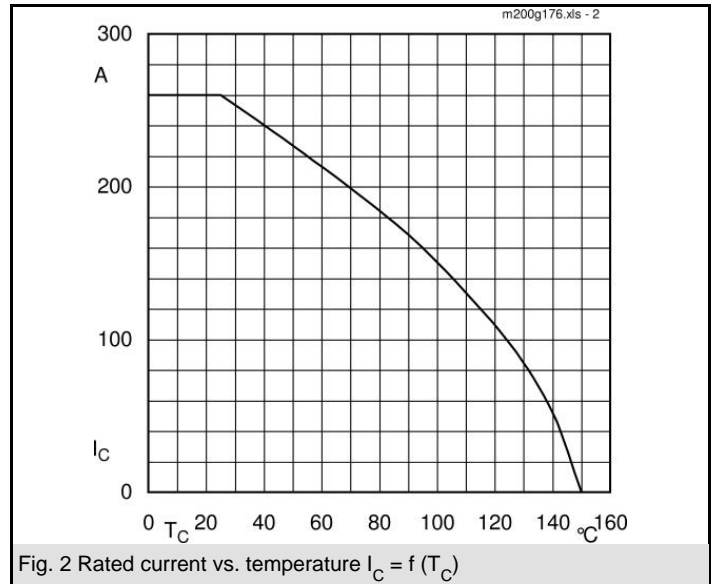
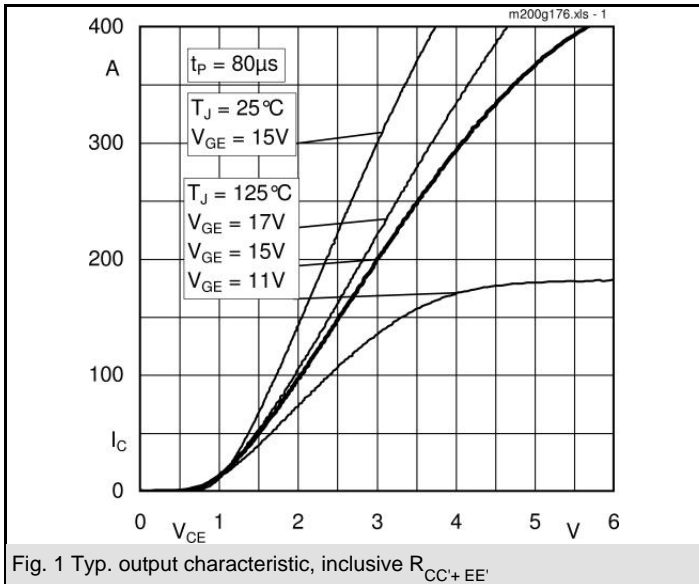

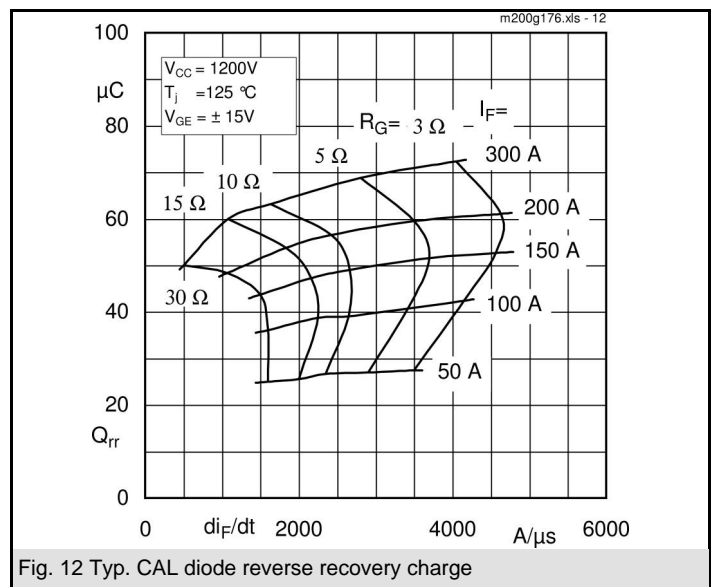
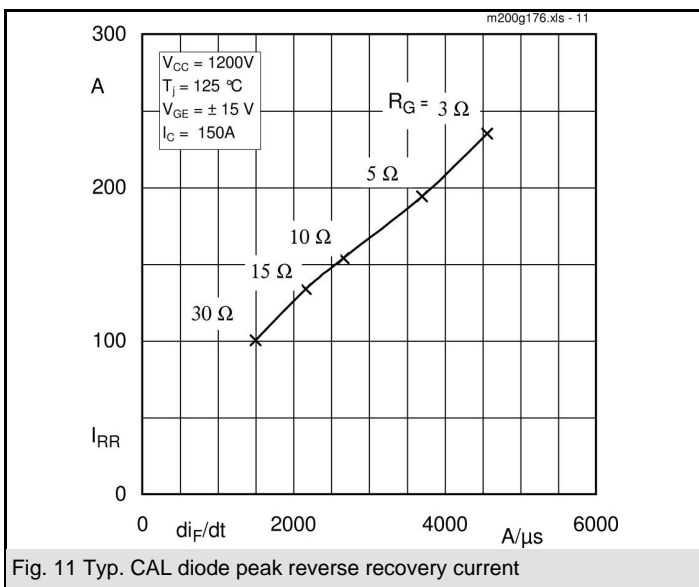
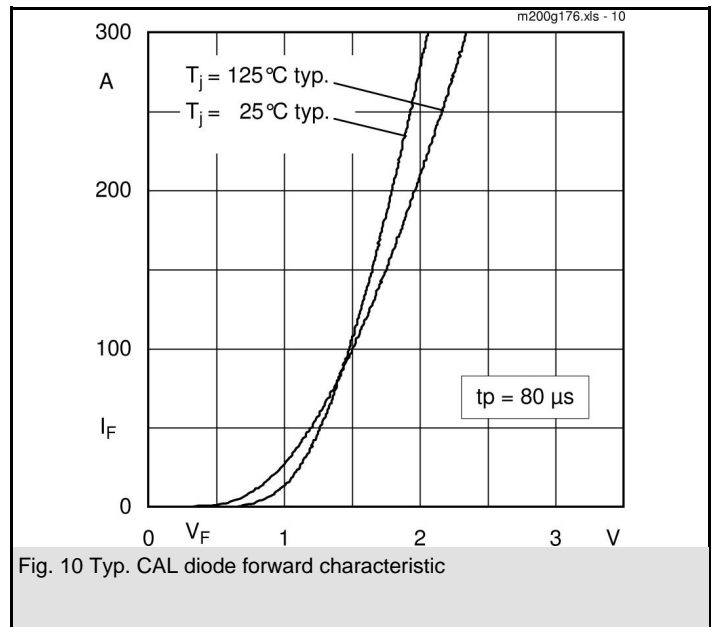
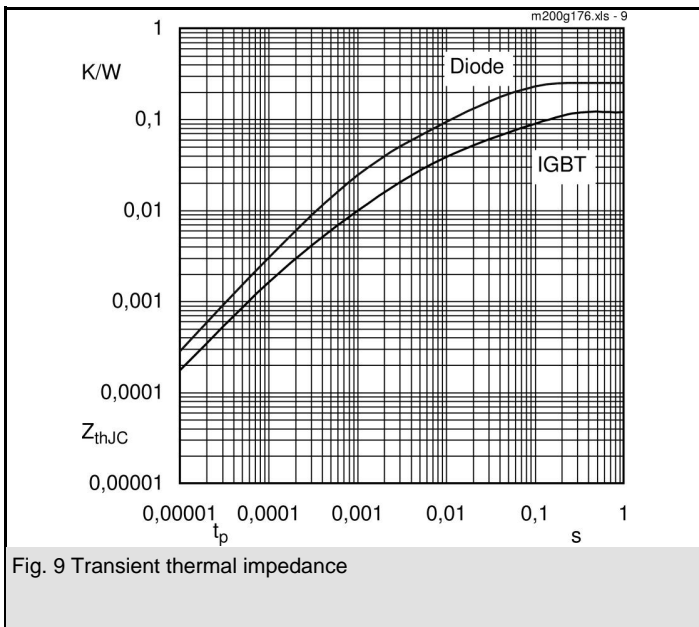
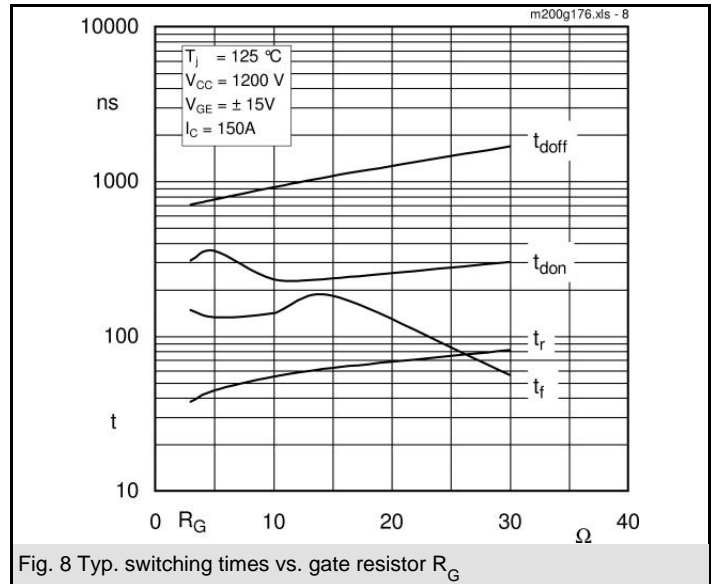
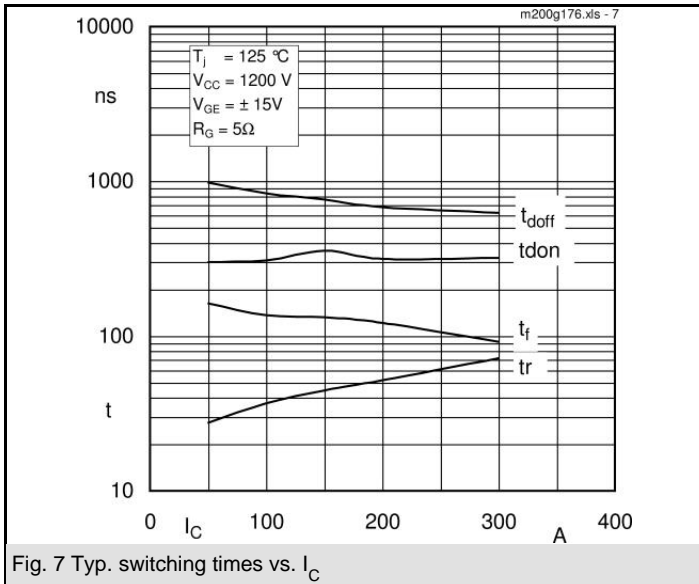

CASED56

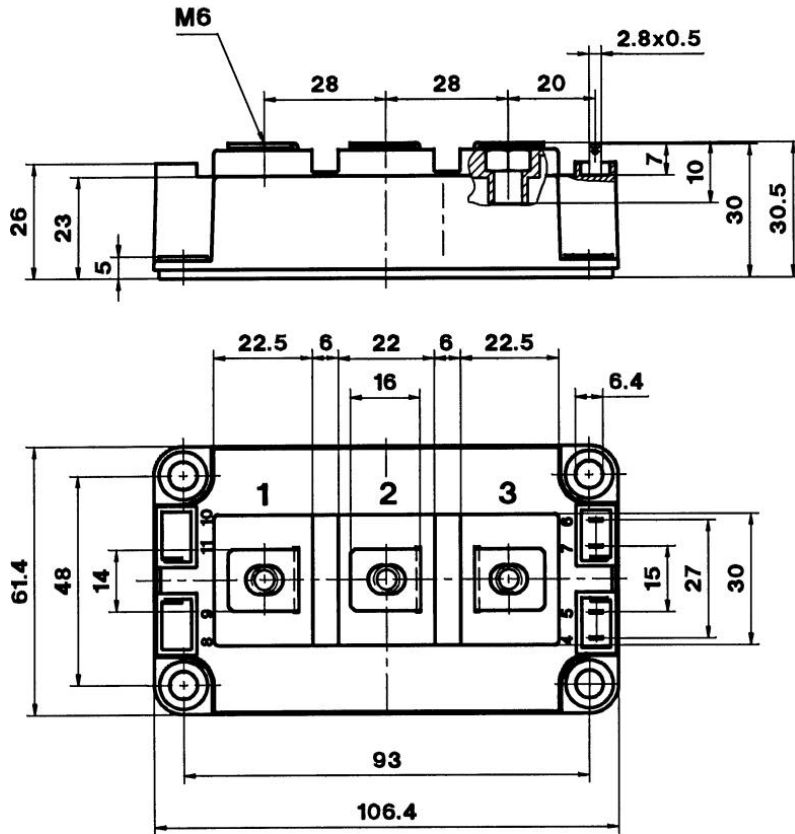

Case D 56

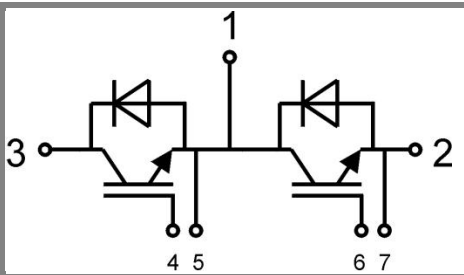

GB

Case D 56

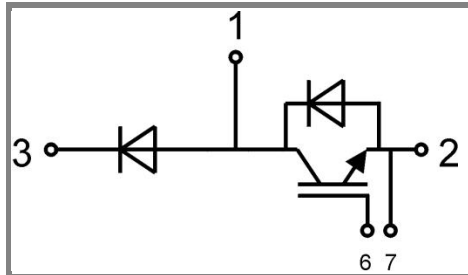

GAL

Case D 57